

# medifa

Member of REINSBERG® GROUP



## medifa 4000 GYN

Examination chairs  
for gynaecology

Made in Germany

# medifa 4000 GYN

- Ergonomic and modern design
- Polished high quality stainless steel edition
- Optimal to clean and disinfect
- User friendly foot switch conception
- Additional hand switch with coloured display (400550/570)
- Accessible for handicapped and elderly people
- 12 memory positions / 4 user accounts
- Time saving by simultaneous drive of engines (memory-positions)
- Various colouring possible
- Small footprint by compact construction
- Maximum permissible overall load of 200 kg



# medifa 4000 GYN

## Examination and treatment chair

### Art.-no. 400520

With the following electrical functions:

- Height adjustment
- Adjustment of pelvis section
- Adjustment of back section

### Shown accessories:

#### Art.-no. 40023

Neck upholstery

#### Art.-no. 81726\_1

Footrests „Comfort“ incl.  
artificial leather cover



## Examination and treatment chair

### Art.-no. 400550

With the following electrical functions:

- Height adjustment
- Adjustment of pelvis section
- Adjustment of back section
- Hand switch
- Memory function with three programmable positions for four operators

### Shown accessories:

#### Art.-no. 40023

Neck upholstery

#### Art.-no. 40000

Powder coated base according to  
RAL colour chart (on request)

#### Art.-no. 42000

Column cover made of  
stainless steel

#### Art.-no. 81717

Leg holders according to Goepel incl.  
artificial leather covering



# medifa 4000 GYN

## Examination and treatment chair

### Art.-no. 400570

With the following electrical functions:

- Height adjustment
- Adjustment of pelvis section
- Adjustment of back section
- Adjustment of leg rests
- Hand switch
- Memory function with three programmable positions for four operators

### Shown accessories:

#### Art.-no. 40023

Neck upholstery

#### Art.-no. 81726\_2

Footrests incl. artificial leather cover











## Basic Features

- Aluminium base and column cover powder coated, white (RAL 9010)
- Seat part and back rest frame made of polished stainless steel
- Electric movements controlled by easy operated cable foot switch
- Electric movements controlled by easy operated hand switch with colour display (Model 400550, 400570)
- Floor levelling screws for secure standing
- Upholstery with ergonomic form, 50 mm thickness
- Head and back upholstery prepared for neck upholstery with magnetic fixation
- Plastic covered backsides of upholstery parts
- Paper roll holder for paper rolls (up to 500 mm) at back rest
- Paper rollable over back rest and seat part, or just over seat part
- Mounting device for side rails (25 x 10 mm), hand grips as well as a fixation device for leg holder system acc. to Goepel
- Extendable, inclinable, detachable white plastic basin
- Safe working load: 200 kg
- Weight of the chair: approx. 110 kg
- Floor space required: 860 x 550 mm
- Power supply: 110/230 V / 50-60Hz , incl. 3 m cable



# Models



	Range	400520	400550	400570
 Height adjustment	550 - 900 mm	●	●	●
 Height adjustment by means of raising pelvis part	230 mm		550 - 1130 mm	
 Adjustment of pelvis section	+20°	●	●	●
 Adjustment of back section	+50°	●	●	●
 Leg holder adjustment	30°	■	■	●
 Memory (12 positions)			●	●
 Hand switch		◆	●	●
 Maximum permissible overall load		200 kg	200 kg	200 kg







● Electrical   ■ Manual   ◆ Optional

# Upholstery colours

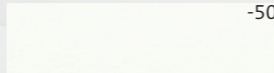
## Upholstery

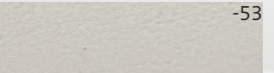
- Ergonomic implementation of upholstery parts
- Rounded rough edges
- High quality artificial leather
- Seamlessly manufactured
- Optimal possibilities to clean and to disinfect
- Various colourings without any extra charge
- Incl. magnetic fixation for neck rest upholstery

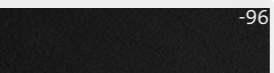

 -50	 -56	 -63	 -67	 -75
White	Beige	Lime	Lemonade	Agave
 -73	 -61	 -65	 -53	 -58
Apricot	Carnelian	Cherry	Pearl	Stone
 -55	 -62	 -74	 -80	 -81
Dolphin	Light Blue	Atoll	Royal	Purple
 -107	 -83	 -96		
Graphite grey	Black	Black, electrically conductive		

# Functionality and Design



# Functionality and Design

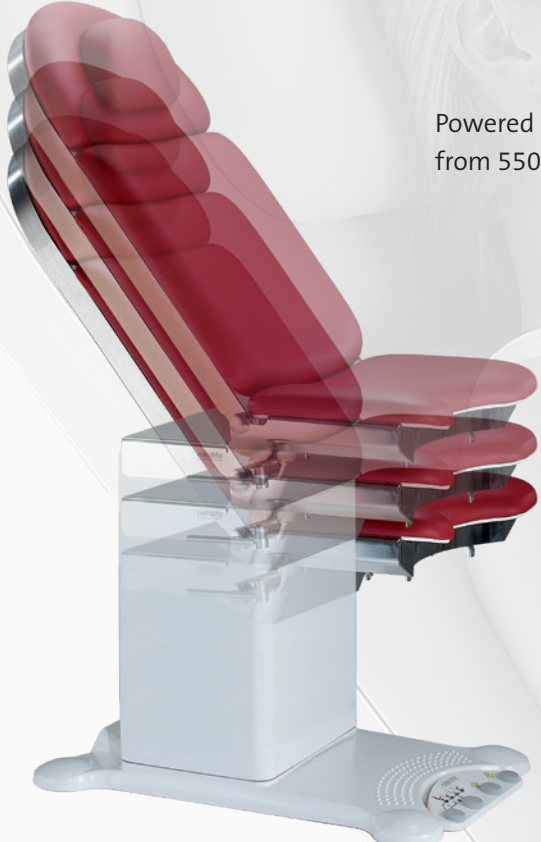

Powered adjustment of height  
from 550 up to 900 mm

The image shows a medical chair with a red seat and backrest, mounted on a light blue base. The chair is shown in a slightly reclined position. The base has a control panel with several buttons and a footrest.



Powered adjustment of leg holder  
system up to 30°  
(Model 400570)

The image shows a medical chair with a red seat and backrest, mounted on a light blue base. The chair is shown in a reclined position. The base has a control panel with several buttons and a footrest. The leg holder system is visible, consisting of several curved metal bars and a footrest.



Powered adjustment of  
pelvis section up to + 20°

The image shows a medical chair with a red seat and backrest, mounted on a light blue base. The chair is shown in a reclined position. The base has a control panel with several buttons and a footrest. The pelvis section is visible, consisting of several curved metal bars and a footrest.



Powered adjustment of  
back section up to +50°

The image shows a medical chair with a red seat and backrest, mounted on a light blue base. The chair is shown in a reclined position. The base has a control panel with several buttons and a footrest. The back section is visible, consisting of several curved metal bars and a footrest.

# Control concept

Learn more about the advantages of the medifa 4000 control concept using the model 400570 as an example.

- Only a few keys ensure simple and intuitive operation
- Control concept can be learned quickly thanks to the same symbols and colour scheme of the control units
- Colour display shows motion performed and selected user level (400550 and 400570 models only)
- Time saving due to synchronous running of the motors in memory mode
- Four user levels, each with three memory positions - ideal for multiple users
- All movements can be immediately stopped and executed again
- All three memory positions can also be activated directly via foot switch

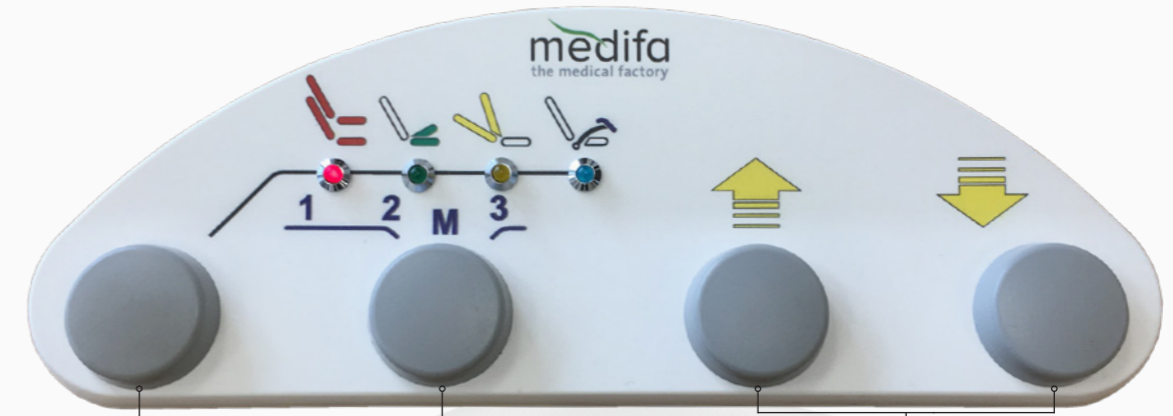
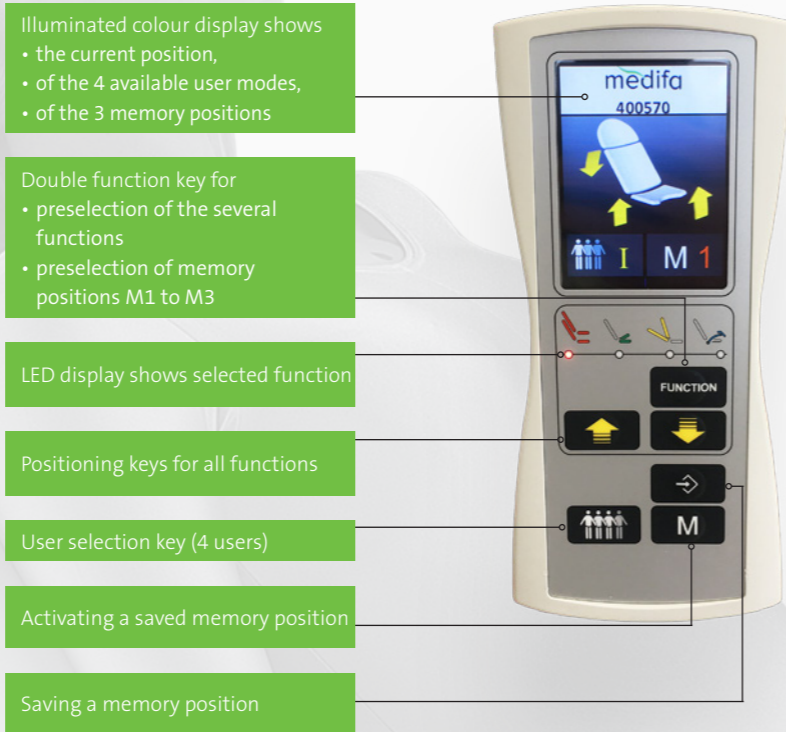

## Exemplary workflow using the memory functions



# Technical Information

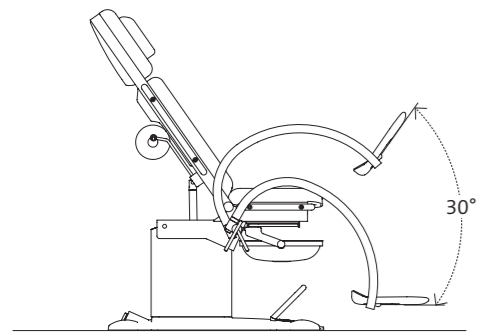
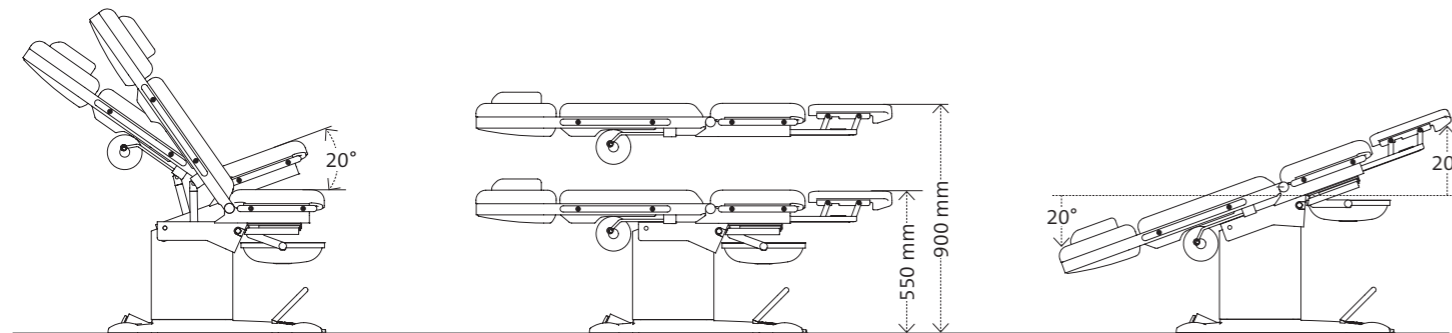
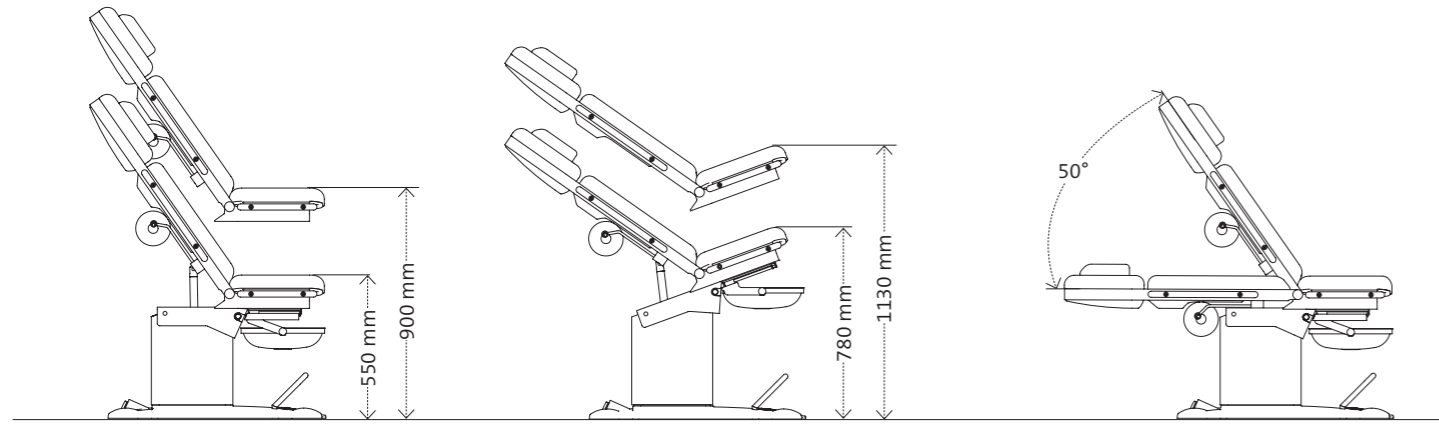

400570

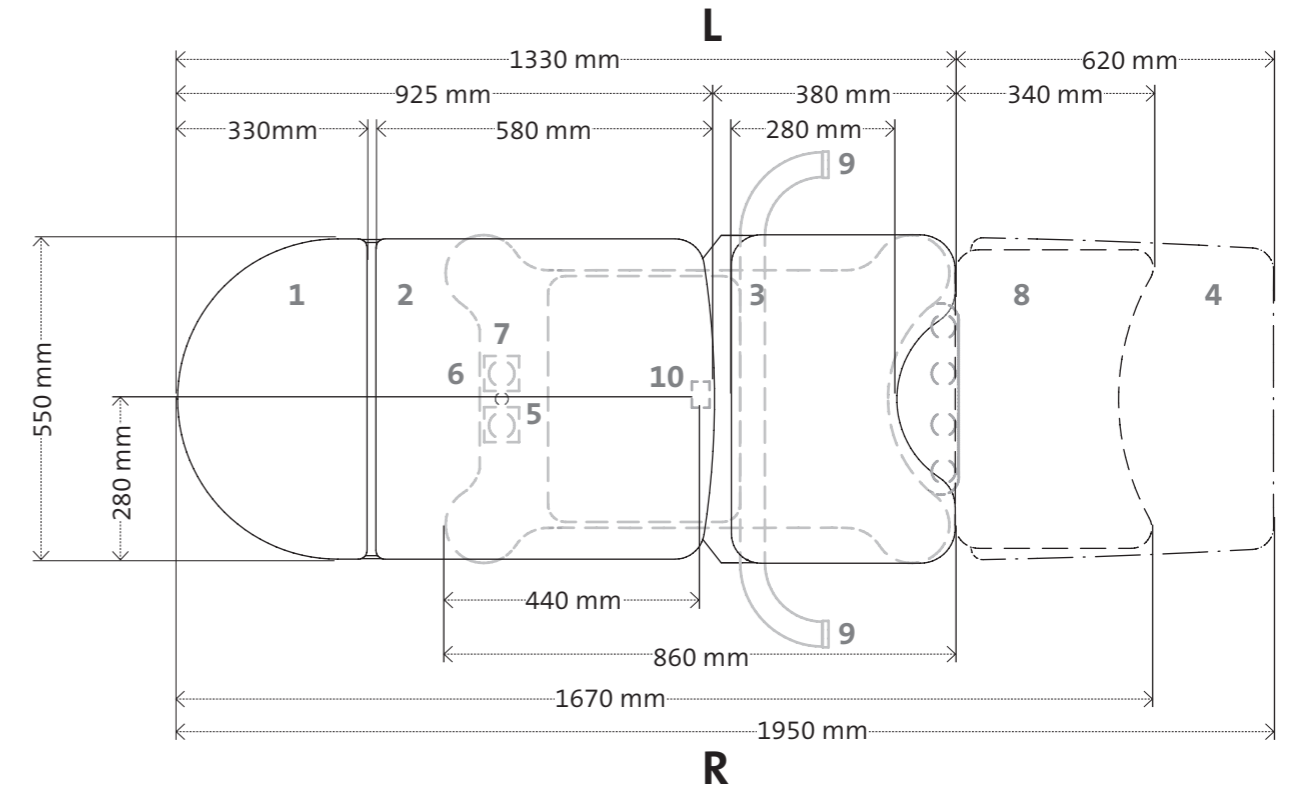

1.	Head upholstery	6.	Power cable outlet
2.	Back upholstery	7.	Socket at the base (accessory 40677)
3.	Pelvis upholstery	8.	Leg plate (accessory 400076)
4.	Leg plate (accessory 400066)	9.	Colposcope holder, right or left (Accessory 82347_System)
5.	Potential equalisation (accessory 40678)	10.	Cable outlet for floor connection

# Leg Holder Systems



## **Art.-no. 81726\_1**

Footrests Comfort (pair), made of stainless steel, with integrated hand grip function and artificial leather cover, for attachment at the chair's tooting elements

- Stepless, gas spring supported one-hand height adjustment
- Pre-adjustment of the footrests by tooting elements at the chair
- Swivelling
- Grey foamed PUR footrests
- Not in combination with items 81072 and 82347\_System



## **Art.-no. 81726\_2**

Footrests (pair), made of stainless steel, with integrated hand grip function and artificial leather cover, for attachment at the chair's tooting elements

- Adjustment of footrests by tooting elements at the chair
- Swivelling
- Grey foamed PUR footrests
- Suitable for electric adjustment (400570)

# Leg Holder Systems



**Art.-no. 81717**

Leg holders according to Goepel (pair), made of stainless steel, with integrated hand grip function and artificial leather cover, for attachment at the chair's tothing elements (only for types 400520, 400550, 400570)

- Adjustment of leg holders by tothing elements at the chair
- Swivelling
- Grey foamed PUR footrests
- Stepless adjustment of the knee bolsters by ball joint
- Suitable for electric adjustment (400570)



**Art.-no. 81705**

Leg holder according to Goepel Comfort with grey foamed PUR knee bolsters (pair)

**Art.-no. 85223**

Side rails at pelvis section for accessory attachment (pair), l = 320 mm, only required for items 81705, 81700 and 81650

**Art.-no. 61511**

Clamps made of stainless steel, rotatable, for side rail attachment (piece)

# Leg Holder Systems



**Art.-no. 81700**

Leg holders according to Goepel Classic with black foamed PUR knee bolsters (pair)

**Art.-no. 81710**

Additional charge for artificial leather cover of knee bolsters (only for item 81700) in upholstery colour



**Art.-no. 400076**

Leg plate for short horizontal positioning of the patient

- Complete insertion of the leg plate below the seat part
- Enlargement of the chair's lying surface up to 1670 mm
- Not in combination with items 400066, 91706 and 91767



**Art.-no. 81650**

Heel supports (pair) for fixation at side rail, made of stainless steel, without clamps



**Art.-no. 400066**

Leg plate for horizontal positioning of the patient

- Leg plate adaption by insertion below the seat part
- Enlargement of the chair's lying surface up to 1950 mm
- Not in combination with item 400076

# Gynaecological Accessories



**Art.-no. 82347\_System**  
Colposcope holder for systems Kaps, Zeiss and Leisegang Atmos, adaptable to the left or to the right, not in combination with item 81726\_1

**Art.-no. 81047\_200**  
Instrument drop made of stainless steel for fixation at column of chair, extendable by means of telescopic rail (Tip-on), with stainless steel bowl (12.5 litres) and stainless steel basket for specula, not in combination with item 40018

Dimensions (Stainless steel bowl):  
L x W x H = 300 x 235 x 200 mm  
Dimensions (Stainless steel basket):  
L x W x H = 230 x 175 x 140 mm



**Art.-no. 81051**  
Stainless steel board with extendible arm, swivelling, adaptable to the left or to the right, dimensions:  
L x W = 413 x 398 mm

**Art.-no. 81072**  
Gyn treatment set with extendible arm 81051, swivelling, adaptable to the left or to the right, not in combination with items 81726\_1 and 91716, incl. additional accessories: 1 stainless steel storing-peel for instruments, 3 glass cups with lids, 3 glass bottles with lids, 4 instrument holster, 1 object slide

# Standard Accessories



**Art.-no. 40677**  
Socket at the base, 2 pieces (cannot be retrofitted)

**Art.-no. 40678**  
Potential equalisation socket at base (cannot be retrofitted)

**Art.-no. 40018**  
Doctor's foot rest made of stainless steel, not in combination with items 81047\_200, 91762 and 91763



**Art.-no. 42000**  
Column cover made of polished stainless steel

**Art.-no. 41000**  
Additional charge for powder coated cover of the column according to RAL colour chart (on request)

**Art.-no. 40000**  
Additional charge for powder coated base according to RAL colour chart (on request)

# Standard Accessories



**Art.-no. 40898**  
Mobility for examination chair, consisting of 4 double leading castors,  $\phi = 75\text{mm}$ , lockable, electrically conductive, not for patient transfer

**Art.-no. 40046**  
Hand switch for control of height adjustment, pelvis section adjustment and back section adjustment (only for item 400520, cannot be retrofitted)



**Art.-no. 81043**  
Storing bowl made of stainless steel, dimensions: L x W x H: 325 x 265 x 65 mm

**Art.-no. 81044**  
same as 81043, but with dimensions (L x W x H): 325 x 176 x 65 mm

**Art.-no. 28530**  
Hand grips, white RAL 9010 (pair), not in combination with items 81717, 81726\_1 and 81726\_2

**Art.-no. 28531**  
Additional charge for artificial leather cover of hand grips in colour of upholstery (pair)



**Art.-no. 40020**  
PVC-protective cover for pelvis part upholstery

**Art.-no. 85222**  
Side rails at back section for accessory attachment (pair), l = 600 mm

**Art.-no. 85223**  
Side rails at pelvis section for accessory attachment (pair), l = 320 mm, only required for items 81705, 81700 and 81650



**Art.-no. 61211**  
Arm rest, rotatable and tiltable by means of ball joint, height adjustable, horizontally slidable, upholstery electrically conductive, incl. clamp and fixture strap, dimensions (upholstery): L x W x H = 400 x 115 x 40 mm

**Art.-no. 40220**  
Arm rest, swivelling, incl. artificial leather covered upholstery in colour of choice, dimensions (upholstery): L x W = 600 x 165 mm

# Standard Accessories



**Art.-no. 40023**  
Neck upholstery, incl. magnetic fixation



**Art.-no. 61805**  
Infusion rod for side rail attachment, stainless steel, incl. rotatable clamp



**Art.-no. 82348**  
Examination luminaire for attachment at holder 82349\_1, 82349\_2 or 82349\_3

- LED technology (50'000 lx / 0.5 m)
- Illuminated field 180 mm
- Precise colour rendering Ra >93
- Light colours 3300 K, 3800 K or 4400 K
- Illumination strength dimmable in five stages
- Operating unit on light head
- Stepless positioning through flexible arm
- Slight thermal radiation in light



**Art.-no. 40070**  
Wall holder made of stainless steel, for attachment of footrests, leg holders, leg plates and further accessories to fix at side rail (25 x 10 mm), dimensions (L x W x H): 300 x 235 x 200 mm



**Art.-no. 82349\_1**  
Holder for examination luminaire, adaptable on the right side

**Art.-no. 82349\_2**  
Holder for examination luminaire, adaptable on the left side

**Art.-no. 82349\_3**  
Examination luminaire holder for examination chair with colposcope holder, adaptable at the right or at the left side

# Additional Furniture

medifa

medifa  
Member of REINSBERG GROUP



**Art.-no. 206020**

Mobile stool with polished five-arm aluminium base, double swivel castors  $\varnothing$  50 mm, height adjustment with gas spring support from 420 to 550 mm via release lever under seat, upholstery made of artificial leather covered foam according to colour chart, dimensions:  
seat:  $\varnothing$  360 mm,  
upholstery: 60 mm,  
base:  $\varnothing$  600 mm



**Art.-no. 206045**

Mobile stool with saddle seat and base ring, polished five-arm aluminium base, double swivel castors  $\varnothing$  50 mm, height adjustment with gas spring support from 420 to 550 mm via release lever under seat, upholstery made of artificial leather covered foam according to colour chart, dimensions:  
seat:  $\varnothing$  400 mm,  
upholstery: 60 mm,  
base:  $\varnothing$  600 mm

**Competence around operating rooms**

As a leading international manufacturer of medical products, medifa GmbH offers innovative products and solutions for operating rooms, mobile hybrid operating systems and other areas in hospitals or outpatient surgical centers. The big product portfolio includes mobile operating tables and operating accessories, mobile carbon operating tables, operating lights, as well as examination and treatment chairs.

The medifa GmbH is a company of the Reinsberg Group, a leading and globally active European manufacturer of medical products and solutions for hospitals.

The development, construction and production of medifa products take place in Germany. With a large share of added value in the company group, medifa guarantees its customers fast response times and high quality “Made in Germany” in accordance with certified national and international quality standards. medifa consistently focuses on the current and future requirements of its customers. In line with the slogan “we care”, customers from all over the world can rely on top-class consultation, processing and quality from a single source.

**Products**

- Operating lights (medifa H!Light)
- Mobile operating tables
- Mobile carbon operating tables for minimal invasive applications
- Accessories for operating tables and lights
- Examination and treatment chairs (gynecology, urology and proctology)
- Medical functional furniture

**medifa worldwide**

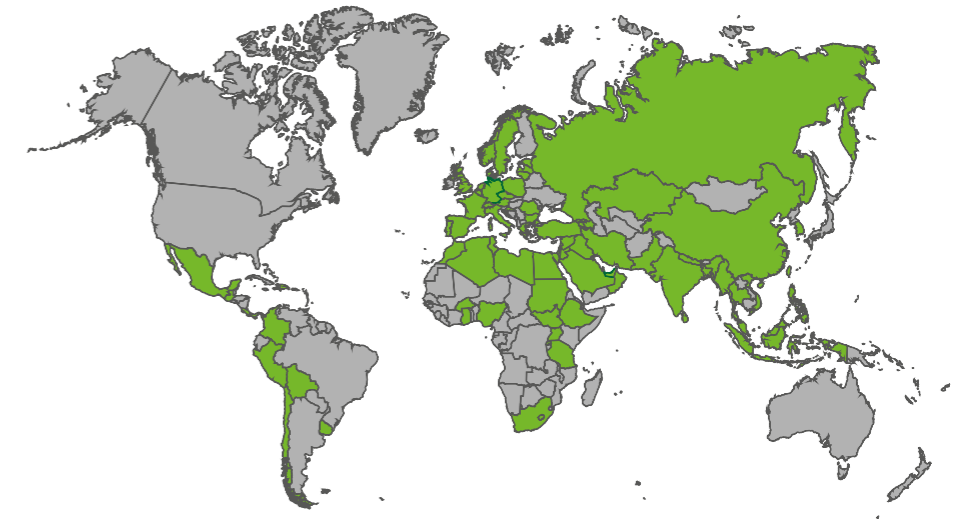

# medifa

Member of REINSBERG® GROUP



## medifa GmbH

Industriestraße 5  
57413 Finnentrop  
Germany  
fon +49 2721 71 77 -0  
fax +49 2721 71 77 -255  
[www.medifa.com](http://www.medifa.com)  
[info@medifa.com](mailto:info@medifa.com)

Version 01-24-EN

Subject to modifications due to technical development.

This document is intended to provide information to an international audience outside of the US.



Made in Germany

[www.medifa.com](http://www.medifa.com)

we care.